



Inclinometers for Hazardous Locations

Current 0..24mA
Voltage 0..10V
Digital RS485
Dual Axis
Up to 360°

2021

Flex™ H6EX-A1 Installation Manual



Ex CONTROLLED DOCUMENT

**THIS DOCUMENT MAY NOT BE MODIFIED WITHOUT PRIOR APPROVAL
FROM THE NOTIFYING AND CERTIFYING BODIES**



H6EX-A1 Installation Manual

Rev D

Page 1 of 9

Table of Contents

Table of Contents	1
List of Figures.....	1
Sensor Description	2
Hazardous Location Information	2
Applicable Standards	3
Normal Locations	3
Hazardous Locations.....	3
EMC	3
H6EX-A1 Instructions for Safety	4
Putting into Service.....	4
Use	4
Assembling and Dismantling	4
Maintenance	5
Installation and Mounting:	5
Adjustment	6
Markings	7
H6EX-A1 Connector Wiring Tables	8
Revision History	9

List of Figures

FIGURE 1: H6EX-A1 CONTROL DRAWING	4
FIGURE 2: H6EX-A1 DIMENSIONS AND MOUNTING (INCHES [MM])	5
FIGURE 3: H6EX-A1 AXIS ORIENTATIONS.....	6
FIGURE 4: TOP SURFACE MARKINGS FOR MODEL AND HAZARDOUS LOCATION INFORMATION	7
FIGURE 5: FRONT SURFACE MARKINGS FOR SERIAL NUMBER	7
FIGURE 6: FACTORY CONFIGURED DEFAULTS LABEL	7

The information and material presented may not be published, broadcast, rewritten, or redistributed without the expressed written consent of Rieker® Inc.
 This document is an Ex Controlled Document and may not be modified without prior Notifying and Certifying Body approval.
 ©2018-2021 Rieker® All Rights Reserved.
 FORM NUMBER: H6EX0010_05/18 UPDATED: 4/29/2021



H6EX-A1 Installation Manual

Rev D

Page 2 of 9

Sensor Description

The H6EX-A1 sensor is an Intrinsically Safe inclinometer that provides high accuracy, dual axis inclination over a range of $\pm 180^\circ$ for Hazardous Locations. The H6EX-A1 must be used with a certified isolation barrier. It is ATEX/IECEX/MET (US)/CSA approved for use in the following hazardous locations:

- Class I & II, Division 1
- Zone 0 & 20.

The sensor incorporates MEMS accelerometers referenced to gravity with integrated temperature compensation over the full operating range of -40° to $+65^\circ$ C for absolute accuracy. It has both digital (RS485) and analog (current or voltage) output options available. Each output is linear with respect to the input angle directly.

The digital RS485 output uses two-wire, half duplex communication, along with a Rieker specific protocol. This protocol can be used to measure the angle of both axes, as well as configure many of the parameters of the sensor.

The H6EX-A1 provides two continuous, fully configurable, analog outputs. These outputs are individually settable to current from 0mA to 24mA or voltage from 0V to 10V, are settable to either axis, and are factory or user configurable to match any angle range and min/max analog values.

Hazardous Location Information

Intrinsically safe equipment is defined as *“equipment which is incapable of releasing sufficient electrical or thermal energy under normal or abnormal conditions to cause ignition of a specific hazardous atmosphere mixture in its most easily ignited concentration.”*

The H6EX-A1 is approved to:

ATEX and IECEX (Gas):

II 1G Ex ia IIC T4 Ga ($-40^\circ\text{C} \leq T_{\text{amb}} \leq +65^\circ\text{C}$)

ATEX and IECEX (Dust):

III 1D Ex ta IIIC T200°C Da ($-40^\circ\text{C} \leq T_{\text{amb}} \leq +65^\circ\text{C}$)

US and Canada (Gas):

Class I, Division 1, Groups A, B, C, D

Class I, Zone 0, AEx ia IIC T4 Ga ($-40^\circ\text{C} \leq T_{\text{amb}} \leq +65^\circ\text{C}$)

US and Canada (Dust):

Class II, Division 1, Groups F, G

Zone 20, AEx ta IIIC T200°C Da ($-40^\circ\text{C} \leq T_{\text{amb}} \leq +65^\circ\text{C}$)

Certificate Numbers:

SEV 18 ATEX 0217

MET E114209

IECEX SEV 18.0042

The H6EX-A1 sensor is intrinsically safe and suitable for all areas except mining, can be used in areas with continuous, long, or frequent periods of exposure to hazardous gas or dust, is suitable for explosive gas Groups IIA to IIC and A to D and dust Groups IIIC & F to G, and has temperature group T4 for gas & T200°C for dust. It also has an extended operating temperature range of -40°C to $+65^\circ\text{C}$.

WARNING: If the equipment is used in a manner not specified by the manufacturer, the protection provided by the equipment may be impaired.

AVERTISSEMENT: Si l'équipement est utilisé de façon non spécifiée par le fabricant, la protection assurée par l'équipement peut être altérée.

Rieker Rugged. Rieker Reliable.™

RIEKER INC • 34 MOUNT PLEASANT ROAD • ASTON • PA • 19014 • USA

610-500-2000

fax: 610-500-2002

support@riekerinc.com

www.riekerinc.com



H6EX-A1 Installation Manual

Rev D

Page 3 of 9

Applicable Standards

Normal Locations

For use in ordinary/unclassified locations, model H6EX-A1 has been investigated in accordance with:

- **UL/CSA 61010 -1 3rd ed.**-Electrical Equipment for Measurement, Control, and Laboratory Use; Part 1

Hazardous Locations

For use in Class I Division 1 and Zone 0, model H6EX-A1 has been investigated in accordance with:

- **UL 913, 8th ed.** - Intrinsically Safe Apparatus and Associated Apparatus for use in Class I, II, and III, Division 1, Hazardous (Classified) Locations.
- **CAN/CSA-C22.2 No. 60079-0:19** - Explosive Atmospheres Part 0: Equipment - General Requirements
- **CAN/CSA-C22.2 No. 60079-11:14** - Explosive Atmospheres Part 11: Equipment protection by Intrinsic Safety "i"
- **IEC 60079-0:2017, Edition 7.0 (EN 60079-0:2018)** - Explosive Atmospheres Part 0: General Requirements
- **IEC 60079-11:2011 6th Edition (EN 60079-11:2012)** - Explosive Atmospheres Part 11: Intrinsic Safety "i"

For use in Class II Division 1 and Zone 20, model H6EX-A1 has been investigated in accordance with:

- **UL/CSA 60079-0** - Explosive Atmospheres Part 0: Equipment – General requirements
- **UL/CSA 60079-31** - Explosive Atmospheres Part 31: Equipment Dust Ignition Protection by Enclosure "t"
- **IEC 60079-0:2017, Edition 7.0 (EN 60079-0:2018)** - Explosive Atmospheres Part 0: General Requirements
- **IEC 60079-31:2013, 2nd edition (EN 60079-31:2014)** - Explosive Atmospheres Part 31: Equipment Dust Ignition Protection by Enclosure "t"

EMC

- **EN 61326-1:2013** - Electrical equipment for measurement, control and laboratory use – EMC requirements
- **47 CFR Ch. 1 - FCC Part 15 Class A** - Radio Frequency Devices - Subpart B - Unintentional Radiators
- **ICES-003 - Issue 6 January 2016 Class A** -Interference-Causing Equipment Standard - Digital Apparatus

The information and material presented may not be published, broadcast, rewritten, or redistributed without the expressed written consent of Rieker® Inc.
This document is an Ex Controlled Document and may not be modified without prior Notifying and Certifying Body approval.
©2018-2021 Rieker® All Rights Reserved.
FORM NUMBER: H6EX0010_05/18 UPDATED: 4/29/2021

Rieker Rugged. Rieker Reliable.™

RIEKER INC • 34 MOUNT PLEASANT ROAD • ASTON • PA • 19014 • USA

610-500-2000

fax: 610-500-2002

support@riekerinc.com

www.riekerinc.com

H6EX-A1 Instructions for Safety

Putting into Service

The H6EX-A1 must be used with a certified Isolation Barrier to supply a nominal +12VDC. The H6EX-A1 has the following entity parameters:

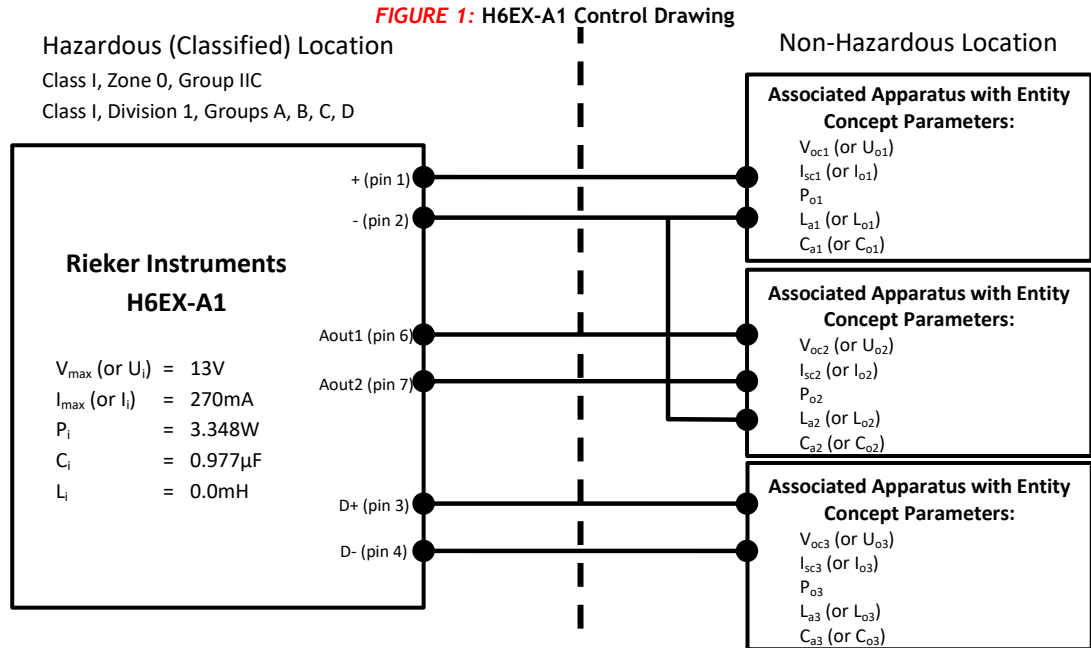

Notes:

- A. The H6EX-A1 requires up to three barriers for operation:
 1. A barrier to supply a nominal 12VDC to the unit (pins 1 and 2).
 2. A barrier to protect the two analog outputs (pins 6 and 7).
 3. A barrier to protect the RS485 lines (pins 3 and 4).
- B. $V_{oc1}, V_{oc2}, V_{oc3} \leq V_{max} \text{ (or } U_i)$ (See note C)
 $I_{sc1} + I_{sc2} + I_{sc3} \leq I_{max} \text{ (or } I_i)$
 $P_{o1} + P_{o2} + P_{o3} \leq P_i$
 $C_a \geq C_i + C_{cable}$
 $L_a \geq L_i + L_{cable}$
- C. The H6EX-A1 ground (pin 2) and all attached barrier grounds MUST be connected together so that V_{max} never exceeds its allowed voltage.
- D. I_{max} (or I_i) is the sum current of all attached barriers.
- E. All grounding path connections should be secure, permanent, visible, and accessible. The grounding path resistance from the farthest barrier to the grounding electrode should not exceed 1 ohm.
- F. The installation must be in accordance with the National Electrical Code, NFPA 70, Articles 504 and 505, Canadian Electrical Code C22.1 Section 18, and ANSI/ISA-RP12.06.01.

Use

The sensor is designed to measure dual-axis inclination and output an analog and/or digital signal.

Assembling and Dismantling

The H6EX-A1 shall not be serviced, dismantled, or re-assembled by the user.

Rieker Rugged. Rieker Reliable.™

RIEKER INC • 34 MOUNT PLEASANT ROAD • ASTON • PA • 19014 • USA

610-500-2000

fax: 610-500-2002

support@riekerinc.com

www.riekerinc.com

Maintenance

No maintenance is required.

Installation and Mounting:

1. On the mounting plane, prepare surface with three tapped holes, H1-H3 for M4/M4.5 mounting screws. H2& H3 are 3.815" [96.9mm] from H1. See *Figure 2*. NOTE that the single hole on the side with the two slots is not meant to be used for mounting.
2. Mount inclinometer to mounting plane using M4/M4.5 mounting screws. Use the two slots for fine adjustments.

Default Horizontal Mount Option: Axis Orientation

The 0° orientation for the horizontal-mount option H6EX-A1 is a desktop, level position.

- For the X-axis, looking at the unit from the side with the connector facing to the right (top right of *Figure 3*), a clockwise rotation from the zero position is considered positive and a counter-clockwise rotation from the zero position is considered negative.
- For the Y-axis, looking at the unit from the front with the connector facing towards you (top left of *Figure 3*), a clockwise rotation from the zero position is considered positive and a counter-clockwise rotation from the zero position is considered negative.

Alternate Vertical Mount Option: Axis Orientation

The 0° orientation for the vertical-mount option of the H6EX-A1 is a vertical position with the connector down.

- For the X-axis, looking at the unit from the top side with the connector facing down (bottom left of *Figure 3*), a clockwise rotation from the zero position is considered positive and a counter-clockwise rotation from the zero position is considered negative.
- For the Y-axis, looking at the unit from the side with the connector facing down and the mounting surface to the left (bottom right of *Figure 3*), a clockwise rotation from the zero position is considered positive and a counter-clockwise rotation from the zero position is considered negative.

FIGURE 2: H6EX-A1 Dimensions and Mounting (Inches [Mm])

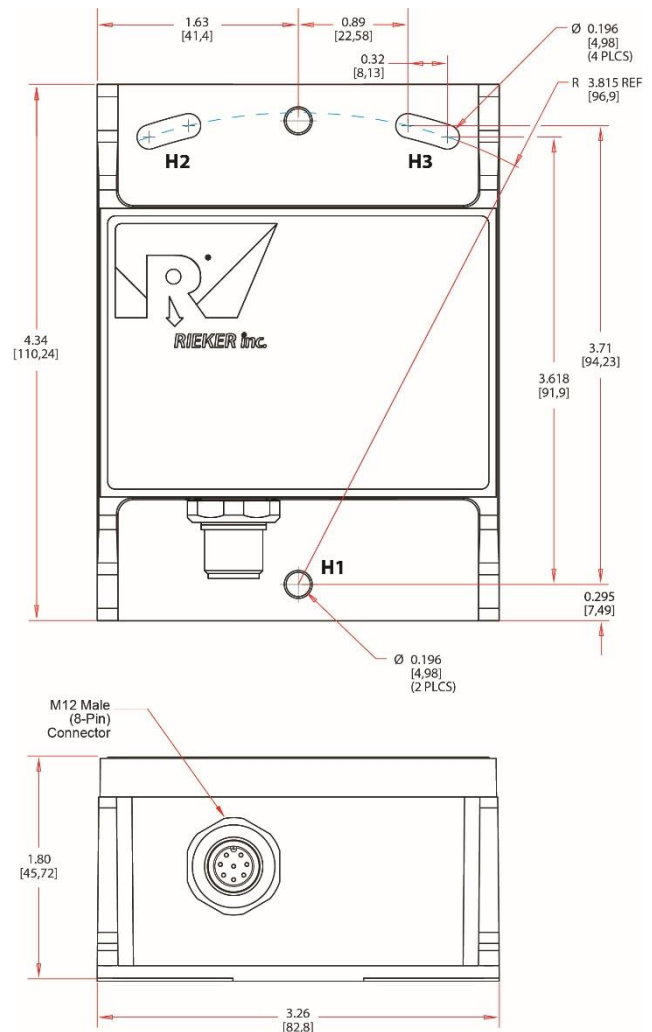
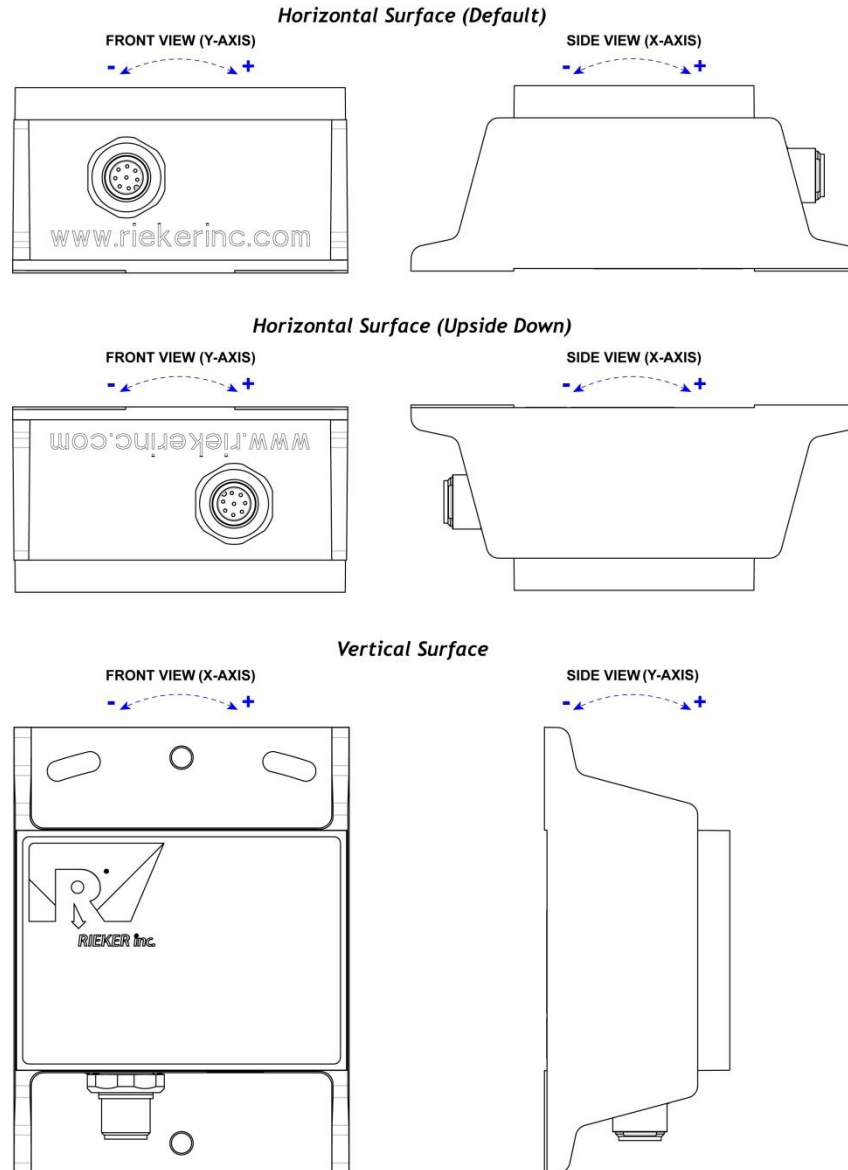

FIGURE 3: H6EX-A1 Axis Orientations



Adjustment

No mechanical adjustment is required.

No software adjustments of H6EX-A1 analog output parameters are permitted. Scaled analog parameters can only be factory-set and must be selected at time of purchase.

The information and material presented may not be published, broadcast, rewritten, or redistributed without the expressed written consent of Rieker® Inc.
 This document is an Ex- Controlled Document and may not be modified without prior Notifying and Certifying Body approval.
 ©2018-2021 Rieker® All Rights Reserved.
 FORM NUMBER: H6EX0010_05/18 UPDATED: 4/29/2021

Markings

The H6EX-A1 shall be marked with the following markings:

FIGURE 4: Top Surface Markings for Model and Hazardous Location Information

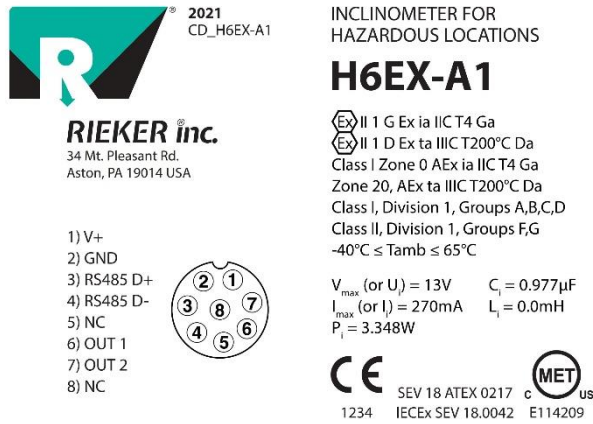
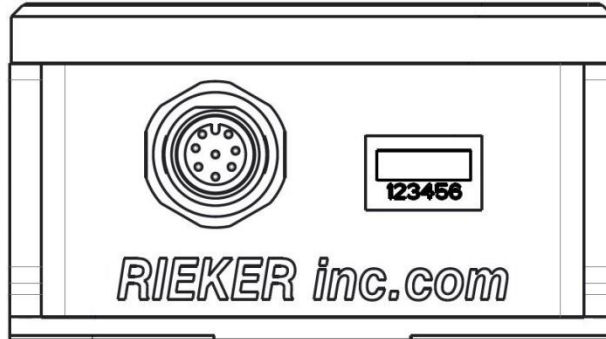
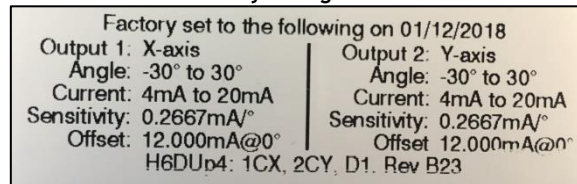

FIGURE 5: Front Surface Markings for Serial Number



In addition, the factory defaults label, located on the box of the H6EX-A1 sensor, provides the configured analog output parameters.

FIGURE 6: Factory Configured Defaults Label



The information and material presented may not be published, broadcast, rewritten, or redistributed without the expressed written consent of Rieker® Inc.
 This document is an Ex Controlled Document and may not be modified without prior Notifying and Certifying Body approval.
 ©2018-2021 Rieker® All Rights Reserved.
 FORM NUMBER: H6EX0010_05/18 UPDATED: 4/29/2021

H6EX-A1 Connector Wiring Tables

TABLE 1: H6EX-A1 MALE 8-PIN INPUT CONNECTOR WIRING	
PIN	FUNCTION
1	SUPPLY VOLTAGE +12VDC
2	POWER / SIGNAL COMMON
3	RS-485 D+
4	RS-485 D-
5	NO CONNECTION
6	ANALOG OUTPUT 1
7	ANALOG OUTPUT 2
8	NO CONNECTION

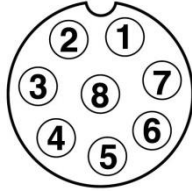

M12 (male 8-pin)
Pin Assignment
FRONT VIEW

TABLE 2: CURRENT SENSE		
R_{sense} is dependent upon supply voltage and cable/wire resistance. Ensure the following equation is met: $R_{sense} \leq \frac{V_{supply} - 2.5}{0.020} - R_{wire}$	QUICK REFERENCE	
	SUPPLY VOLTAGE	SENSE RESISTOR
	12V	200-350 OHMS

NOTE: The H6EX-A1 Sensor's Chassis Ground is NOT the same as the signal ground for the current output return. The analog output return must be connected to the POWER/SIGNAL COMMON (pin 2).

The information and material presented may not be published, broadcast, rewritten, or redistributed without the expressed written consent of Rieker® Inc.
 This document is an Ex Controlled Document and may not be modified without prior Notifying and Certifying Body approval.
 ©2018-2021 Rieker® All Rights Reserved.
 FORM NUMBER: H6EX0010_05/18 UPDATED: 4/29/2021



H6EX-A1 Installation Manual

Rev D

Page 9 of 9

Revision History

Revision	Revision Date	Description of Changes	Approved By
Rev A	05/30/2018	Initial Release.	Caleb Swieson
Rev B	12/26/2018	Updated entity parameters.	Caleb Swieson
Rev C	01/20/2021	Add dust atmosphere certifications. Updated applicable standards.	Caleb Swieson
Rev D	04/22/2021	Updated Controlled Document warning per CN 21-04-008.	Caleb Swieson

The information and material presented may not be published, broadcast, rewritten, or redistributed without the expressed written consent of Rieker® Inc. This document is an Ex Controlled Document and may not be modified without prior Notifying and Certifying Body approval. ©2018-2021 Rieker® All Rights Reserved. FORM NUMBER: H6EX0010_05/18 UPDATED: 4/29/2021

Rieker Rugged. Rieker Reliable.™

RIEKER INC • 34 MOUNT PLEASANT ROAD • ASTON • PA • 19014 • USA

610-500-2000

fax: 610-500-2002

support@riekerinc.com

www.riekerinc.com